

ALL ECO Desktop screen clamps

All desktop screens are supplied complete with one set of 2 clamps to your choice excluding special clamps, Screen clamps can be purchased separately.

The clamps on this page have been designed to fit 98% of all standard desks, should these standard fixings not be suitable for your desks then we will resolve this by manufacturing bespoke clamps.

The clamps illustrated have been designed to fit ECO's fabric & acrylic ranges of desktop screens.

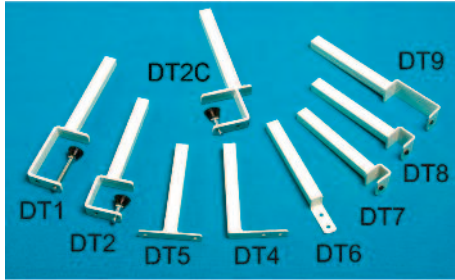

DT1	30-85mm	DT6	screw on
DT2	18-49mm	DT7	18mm
DT2C	18-49mm	DT8	25mm
DT4	screw on	DT9	80mm
DT5	screw on		

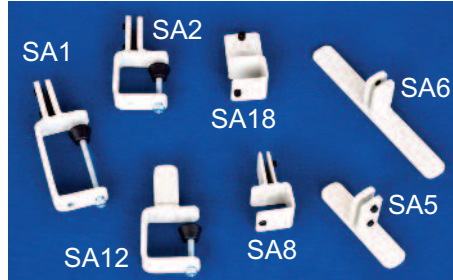

SA1	30-85mm	SA12	18-49mm
SA2	18-49mm	SA18	25mm
SA5	11cm foot	Fits 3-6mm acrylic	
SA6	20cm foot		
SA8	25mm		

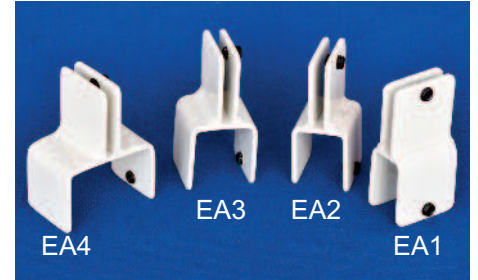

EA1	20mm
EA2	25mm
EA3	33mm
EA4	50mm
Fits 3-6mm acrylic	

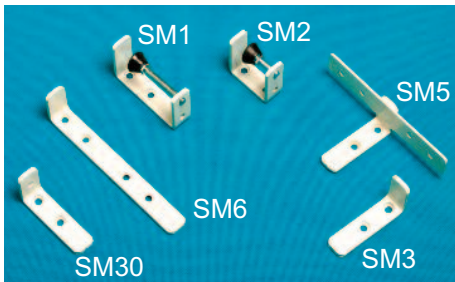

SM1	30-85mm	SM30	screw on
SM2	18-49mm		
SM3	rest on		
SM5	screw on		
SM6	screw on		

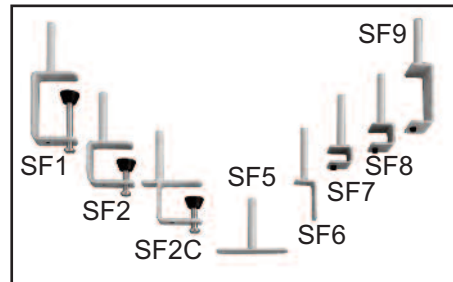

SF1	30-85mm	SF7	20mm
SF2	18-49mm	SF8	25mm
SF2C	18-49mm	SF9	80mm
SF5	screw on		
SF6	screw on		

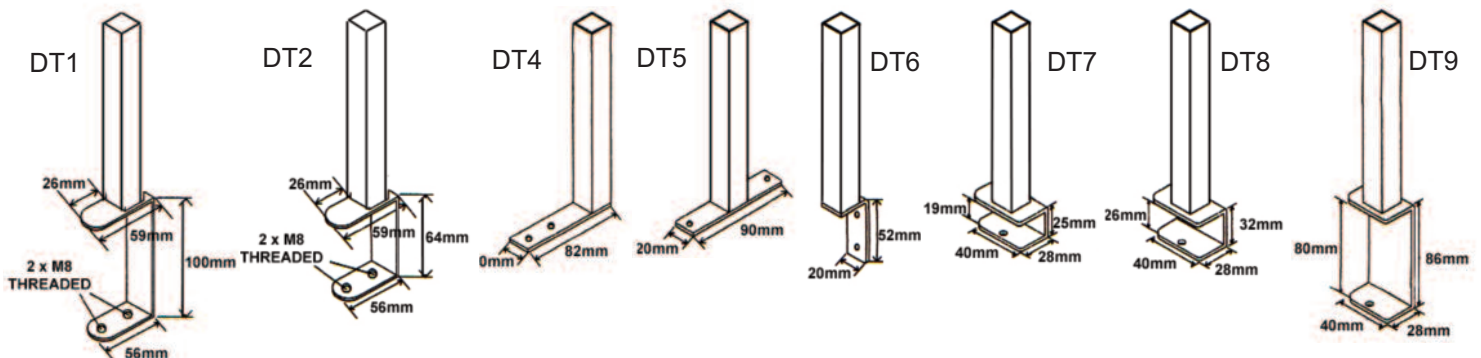
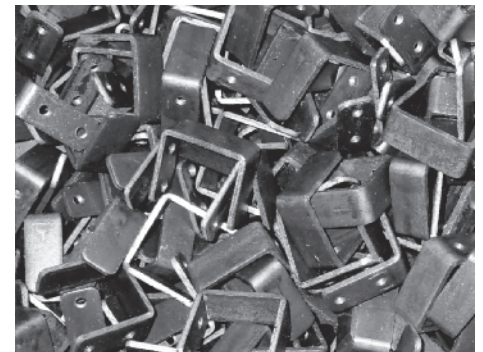

Please insert the measurements for the desk top that matches the nearest to the desk you intend to clamp the desktop screen to.

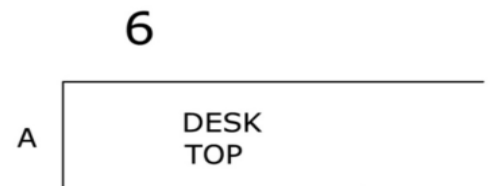
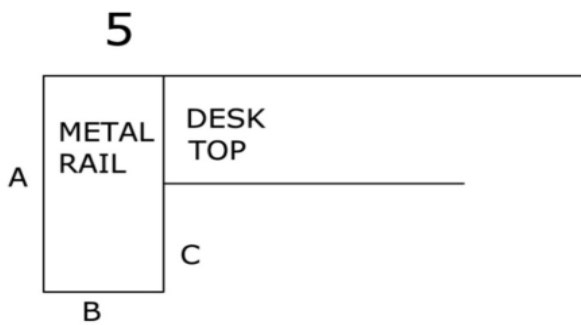
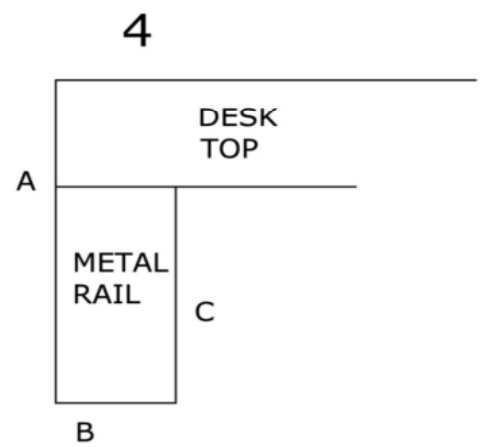
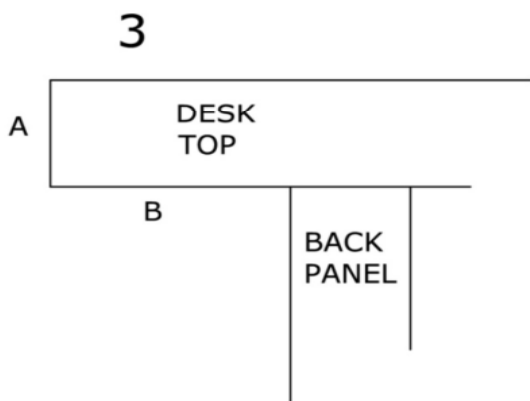
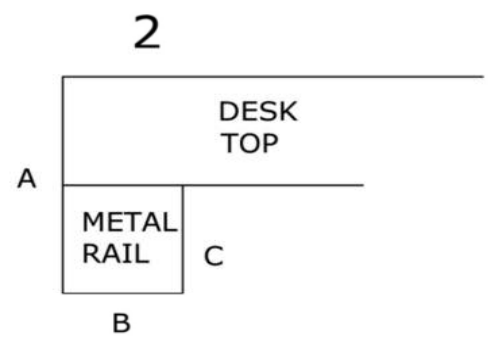
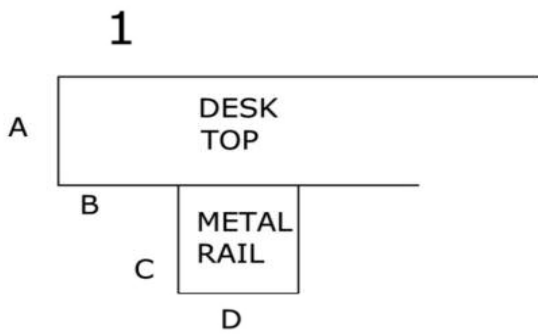

Please write your dimensions below plus any special details that you think may be relevant.				
Profile Type	Size A	Size B	Size C	Size D
1	_____mm	_____mm	_____mm	_____mm
2	_____mm	_____mm	_____mm	
3	_____mm	_____mm		
4	_____mm	_____mm	_____mm	
5	_____mm	_____mm	_____mm	
6	_____mm			